

REVISION RECORD				
REV	ECN	DESCRIPTION	DRFT	DATE

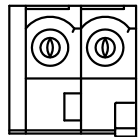

02P

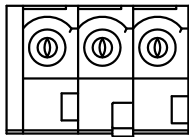

03P

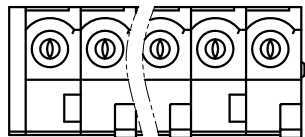

NOTES1:

UL Standard

- 1.Rated voltage/current : 300V / 15A
- 2.Withstanding voltage : AC1600V/1Min.

IEC Standard

1. Pollution Degree	3
Overvoltage Category	III
Rate Impulse Voltage(KV)	4.0KV
Rate Voltage(V)	320V
Rate Current(A)	20A

NOTES2:

- 1.Dimension shall be interpreted per ASME Y14.5-2009
- 2.Pitch : 5.00mm, Poles : N=02~24P
- 3.Operating temperature:-40°C~+105°C
- 4.Undimensioned tolerances:

Pitch range in mm		Nominal dimension range in mm				0.1/10
TO	Over	TO	Over	TO	Over	
6	10	10	30	30	60	±2*
10	24	30	60	100	150	
±0.15	±0.20	±0.30	±0.30	±0.50	±0.70	±1.00
						±1.30

5.RoHS Compliance

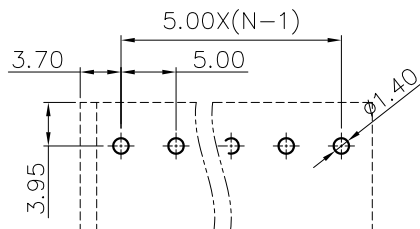
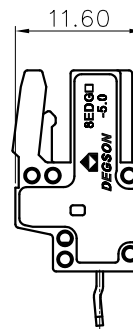
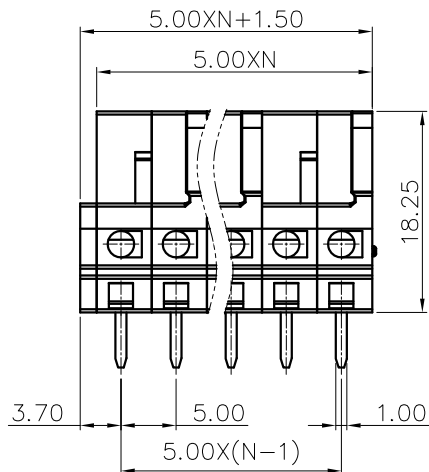
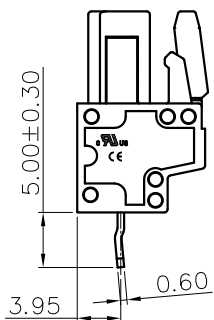

P.C.B LAYOUT

8EDGB - 5.0 - XXP - 1Y - 00A (H)
 (Series No.)(Pitch)(Poles)(Single Pitch) (Color):1.(Grey)
 2.(Blue)
 3.(Black)
 4.(Green)
 5.(Orange)
 6.(Red)
 7.(Transparent)
 8.(Yellow)
 9.(White)

DETACHED LISTS	PART NO.:	NINGBO DEGSON ELECTRICAL CO., LTD			
	APPD:	NAME: 8EDGB-5.0-XXP-1Y-00A(H)			
	CHKD:	TITLE: CUSTOMER DRAWING			
	DRFT:	DRAWING NO.:		REV	DO
	THIRD ANGLE PROJECTION		MM (INCH)	DO NOT SCALE DRAWING	SCALE 1:1