

REVISION RECORD

REV	ECN	DESCRIPTION	DRFT	DATE
-----	-----	-------------	------	------

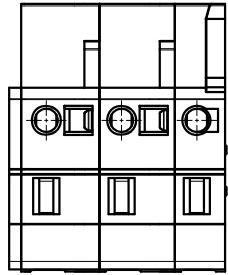

\*03P

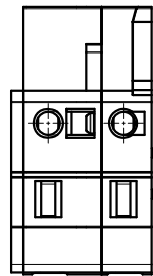
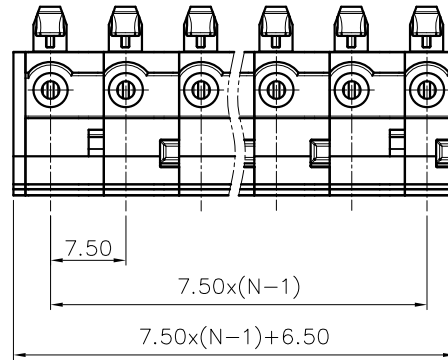

\*02P

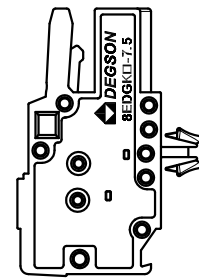
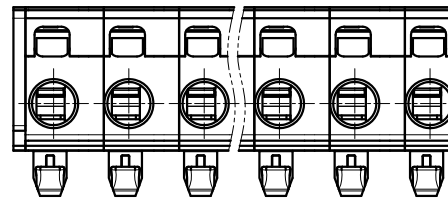
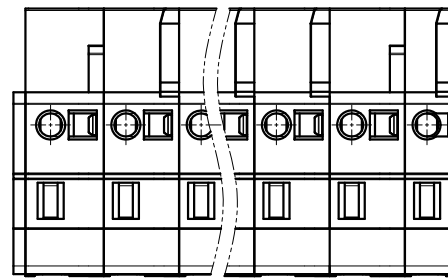
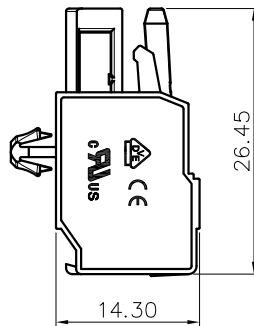

NOTES1:

UL Standard

- 1.Rated voltage/current : 300V / 15A
- 2.Withstanding voltage : AC1600V/1Min.
- 3.Wire range : 22~14AWG

IEC Standard

1. Pollution degree	3
Overvoltage category	III
Rate impulse voltage(KV)	4.0KV
Rate voltage(V)	400V
Rate current(A)	20A

2. Wire range : 0.2~2.5mm<sup>2</sup>

NOTES2:

- 1.Dimension shall be interpreted per ASME Y14.5-2009
- 2.Pitch : 7.50mm, Poles : N=02~12P
- 3.Stripping length : 9~10mm
- 4.Operating temperature : -40°C~+105°C
- 5.Undimensioned tolerances:

Pitch range in mm		Nominal dimension range in mm					-	∩	∠
TO	Over TO	TO	Over TO	TO	Over TO	TO	Over TO	0.1/10	
6	6 TO 10	6	6 TO 10	6 TO 30	6 TO 30	6 TO 100	6 TO 150	<	
±0.15	±0.20	±0.30	±0.30	±0.50	±0.70	±1.00	±1.30	±2'	

6.RoHS Compliance

8EDGKC - 7.5 - XXP - 1Y - 1000A (H)  
 (Series No.)(Pitch) (Poles)(Single Pitch) (RoHS)  
 1000A-(Standard)  
 (Color) :1.(Grey)2.(Blue)3.(Black)4.(Green)5.(Orange)  
 6.(Red)7.(Transparent)8.(Yellow)9.(White)

DETACHED LISTS	PART NO.:	宁波高松电子有限公司 NINGBO DEGSON ELECTRICAL CO., LTD			
	APPD:	NAME: 8EDGKC-7.5-XXP-1Y-1000A(H)			
	CHKD:	TITLE: CUSTOMER DRAWING			
	DRFT:	DRAWING NO.:		REV	DO
 THIRD ANGLE PROJECTION		DO NOT SCALE DRAWING SCALE 1:1		SHEET 1/1	